

**SOT-23-3L DIGITAL TRANSISTORS
TRANSISTOR (NPN)**

FEATURES

- * Built-in bias resistors enable the configuration of an inverter circuit without connecting external input resistors.(see equivalent circuit)
- * The bias resistors consist of thin-film resistors with complete isolation to allow negative biasing of the input. They also have the advantage of almost completely eliminating parasitic effects.
- * Only the on/off conditions need to be set for operation marking device design easy.

MECHANICAL DATA

- * Case: Molded plastic
- * Epoxy: UL 94V-O rate flame retardant
- * Lead: MIL-STD-202E method 208C guaranteed
- * Mounting position: Any
- * Weight: 0.009 gram

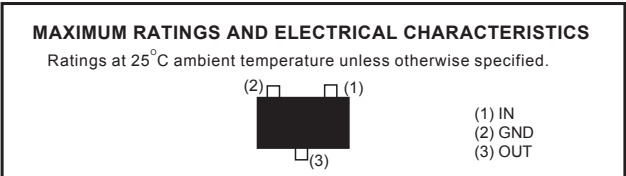
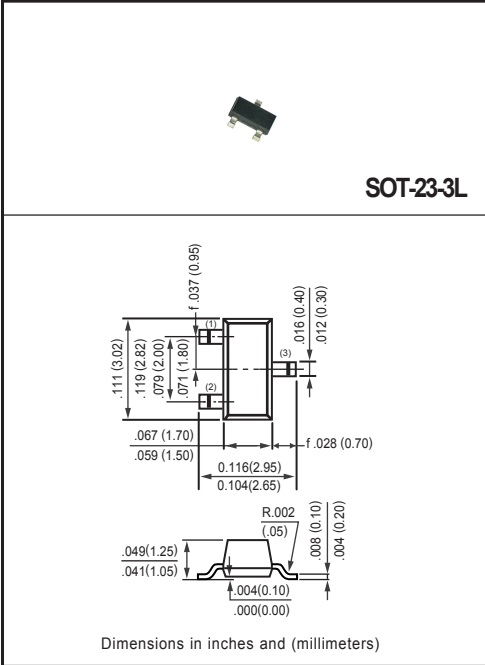

MAXIMUM RATINGS (@ TA = 25°C unless otherwise noted)

RATINGS	SYMBOL	VALUE	UNITS
Supply Voltage	V _{CC}	50	V
Input Voltage	V _{IN}	-7~+20	V
Output Current	I _O	100	mA
	I _{C(MAX)}	100	
Power dissipation	P _d	200	mW
Junction temperature	T _J	150	°C
Storage Temperature	T _{STG}	-55 to +150	°C

ELECTRICAL CHARACTERISTICS (@ TA = 25°C unless otherwise noted)

CHARACTERISTICS	SYMBOL	MIN.	TYP.	MAX.	UNITS
Input voltage (V _{CC} = 5V, I _O =100uA)	V _{I(off)}	-	-	0.3	V
	V _{I(on)}	2.5	-	-	V
Output voltage (I _O /I _I =10mA/0.5mA)	V _{O(on)}	-	0.1	0.3	V
Input current (V _I = 5V)	I _I	-	-	1.8	mA
Output current (V _{CC} = 50V, V _I =0)	I _{O(off)}	-	-	0.5	mA
DC current gain (V _O = 5V, I _O = 10mA)	G _I	30	-	-	
Resistance ratio	R ₂ /R ₁	1.7	2.1	2.6	
Transistion frequency (V _O = 10V, I _O = 5mA, f=100MHz)	f _T	-	250	-	MHz
Input resistance	R ₁	3.29	4.7	6.11	KΩ

NOTE: "Fully ROHS compliant", "100% Sn plating (Pb-free)".

RATING AND CHARACTERISTICS CURVES (DTC143XKA)

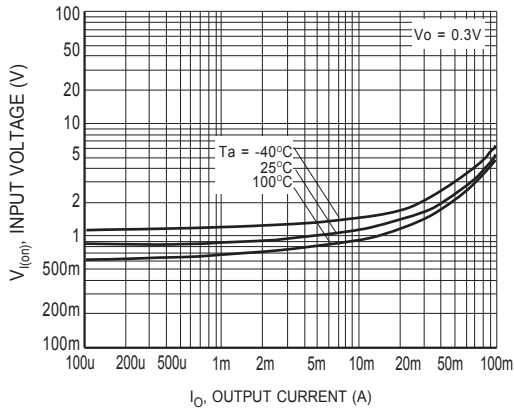

Figure1 Input voltage vs. output current (ON characteristics)

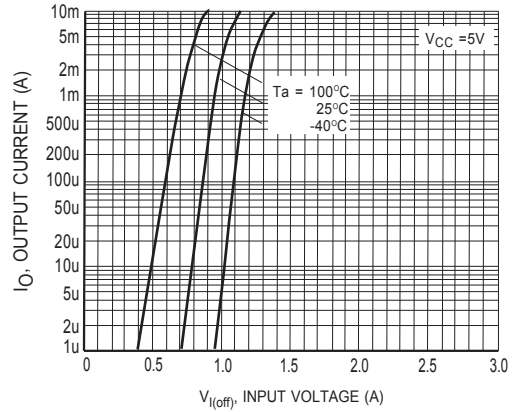

Figure2 Output current vs. input voltage (OFF characteristics)

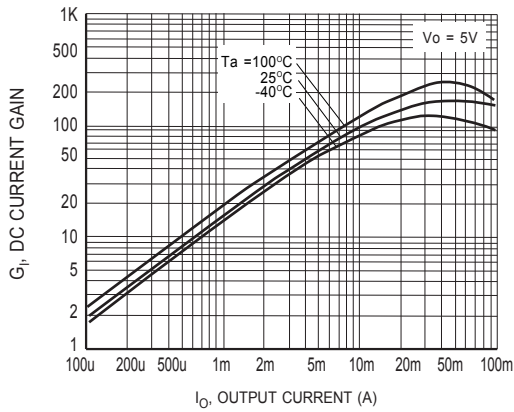

Figure3 DC current gain vs. output current

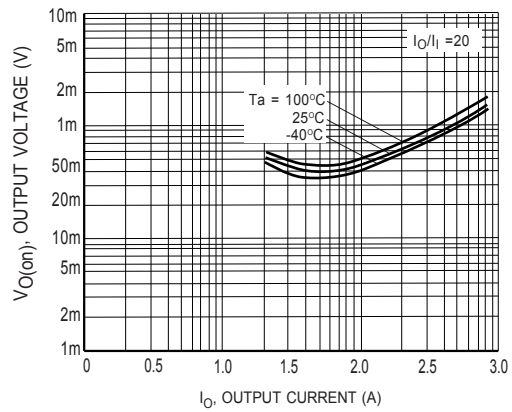

Figure4 Output voltage vs. output current

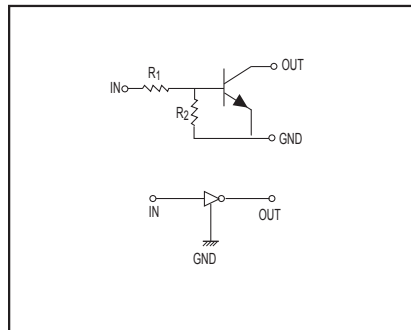

Figure5 Equivalent circuit

DISCLAIMER NOTICE

Rectron Inc reserves the right to make changes without notice to any product specification herein, to make corrections, modifications, enhancements or other changes. Rectron Inc or anyone on its behalf assumes no responsibility or liability for any errors or inaccuracies. Data sheet specifications and its information contained are intended to provide a product description only. "Typical" parameters which may be included on RECTRON data sheets and/ or specifications can and do vary in different applications and actual performance may vary over time. Rectron Inc does not assume any liability arising out of the application or use of any product or circuit.

Rectron products are not designed, intended or authorized for use in medical, life-saving implant or other applications intended for life-sustaining or other related applications where a failure or malfunction of component or circuitry may directly or indirectly cause injury or threaten a life without expressed written approval of Rectron Inc. Customers using or selling Rectron components for use in such applications do so at their own risk and shall agree to fully indemnify Rectron Inc and its subsidiaries harmless against all claims, damages and expenditures.